

ITEM NO. : B3334BU

ASSEMBLY INSTRUCTIONS

1. Attach the lampshade (A) to the canopy (B) with the screws (C) and then secure the screws with the nuts (D).
2. Install the mounting plate (E) on the outlet box with the screws (F).
3. Loosen the hex nuts around the bolts (G) and screw in or unscrew the bolts from the junction box to get the right length for installation.
4. Connect the fixture wire to the circuit wire with the wire nuts (H): black wire with live wire, white wire with neutral wire, ground wire with ground wire. Turn the wire nuts to twist the wires together. Wrap the wire nuts with insulated rubber tape.
5. Fix the lamp body (B) to the mounting plate (E) with ball nuts (J).
6. Screw the bulb (K) into the lamp holder.

Please consult a qualified Electrician if you are not familiar with electrical wiring.

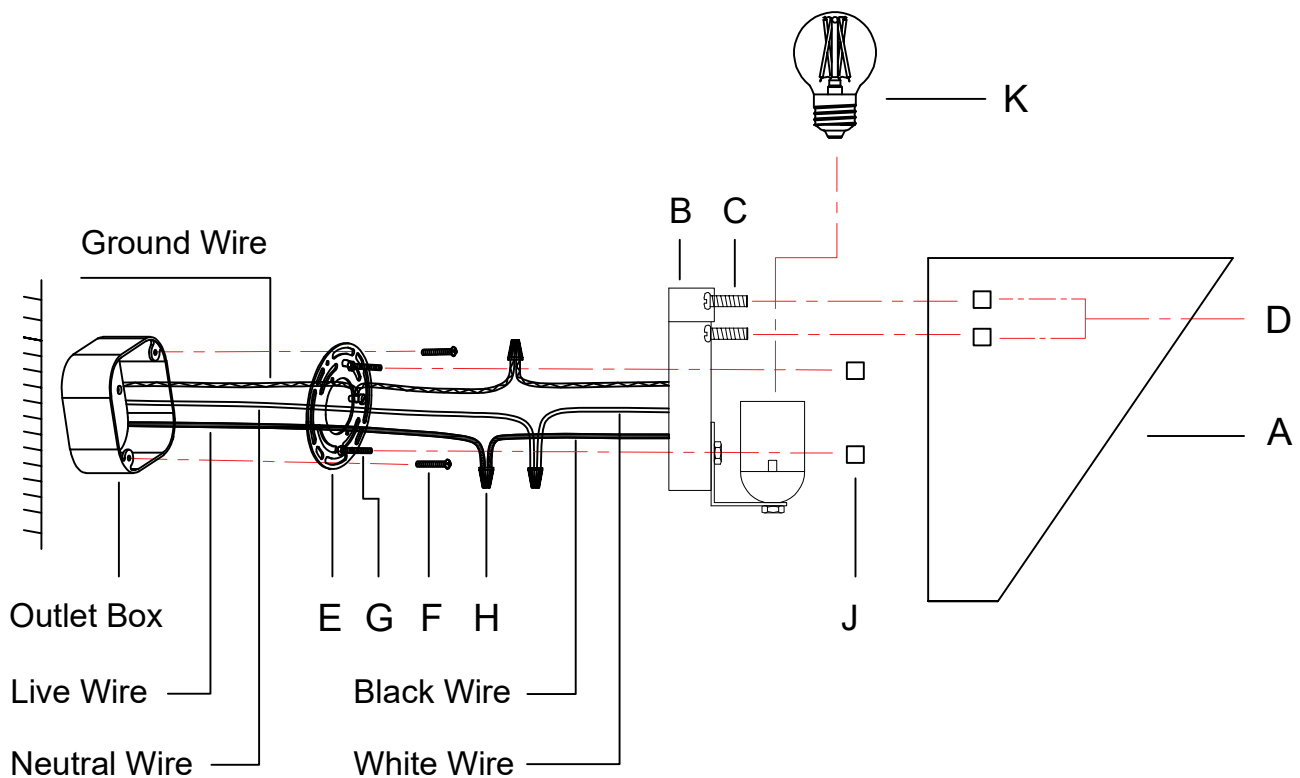

Recommended bulb shape

